



vision solution

Specification

SBS-SCJ300-0.053

High Resolution Double Telecentric Lens

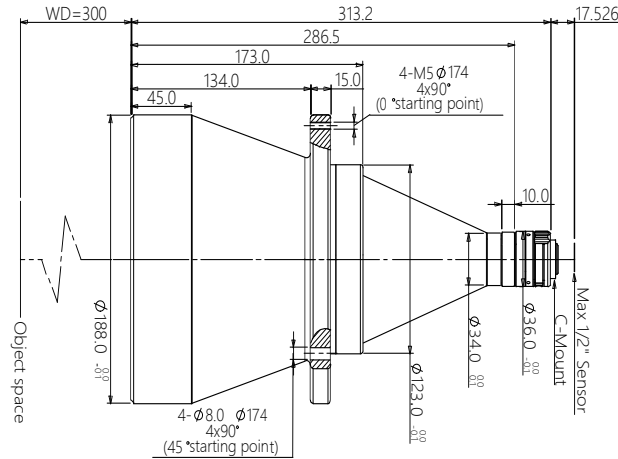

Features (SBS-SCJ series)

- * Excellent double telecentric design for high resolution image result.
- * Field of view is from 26mm to 300mm, suitable for most of application.
- * Big Iris, low distortion, high parallel degree, big depth of view.
- * Sensor size is available for 1/2.5" 1/2" 1/1.8" 2/3" 1" 4/3" 1.75" 2" ϕ 39 35mm full.

Parameters

FOV (Dia.mm)	150
Mag.(x)	0.053
WD (mm)	300 \pm 5
Sensor size (Dia.mm)	8.0(1/2")
Image F#	4.2
Image MTF30(pl/mm)	>210
Object DOF (mm)	\pm 156@F11
Object distortion (%)	<0.1
Object telecentric degree	<0.1
Object I/O(mm)	631 \pm 5

Mechanical

Mount	C
Total length (mm)	313.2
N.W(KG)	5.6

Field of View (mm x mm)

1/2.5" 9P001/31 (5.7x4.28)	107.5x80.8
1/2.3" 9J003 (6.44x4.62)	121.5x87.2