



vision solution

Specification

SBS-SCJ300-0.06

High Resolution Double Telecentric Lens

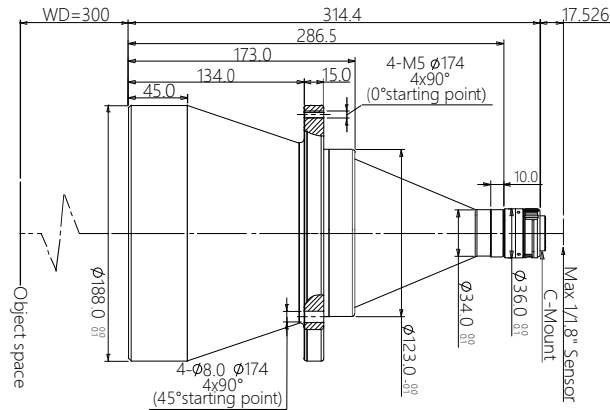

Features (SBS-SCJ series)

- * Excellent double telecentric design for high resolution image result.
- * Field of view is from 26mm to 300mm, suitable for most of application.
- * Big Iris, low distortion, high parallel degree, big depth of view.
- * Sensor size is available for 1/2.5" 1/2" 1/1.8" 2/3" 1" 4/3" 1.75" 2"Φ39 35mm full.

Parameters

FOV (Dia.mm)	150
Mag.(x)	0.060
WD (mm)	300±5
Sensor size (Dia.mm)	9.0(1/1.8")
Image F#	4.6
Image MTF30(pl/mm)	>195
Object DOF (mm)	±122@F11
Object distortion (%)	<0.1
Object telecentric degree	<0.1
Object I/O(mm)	632±5

Mechanical

Mount	C
Total length (mm)	314.4
N.W(KG)	5.7

Field of View (mm x mm)

1/1.8" IMX178 (7.43x4.9)	123.8x81.7
1/1.8" IMX252/265 (7.1x5.3)	118.3x88.3